













 $\varnothing 6,3 \times 50 \text{ mm}$ <b>A1 x 18</b>	 $\varnothing 12 \text{ mm}$ <b>A2 x 18</b>	 4 mm <b>A3 x 1</b>	 $\varnothing 15 \times 12 \text{ mm}$ <b>B1 x 10</b>	 $\varnothing 5 \times 44 \text{ mm}$ <b>B2 x 10</b>
 $\varnothing 20 \text{ mm}$ <b>B3 x 10</b>	 19x14 mm <b>C x 12</b>	 $\varnothing 4 \times 16 \text{ mm}$ <b>D1 x 34</b>	 $\varnothing 4 \times 30 \text{ mm}$ <b>D2 x 6</b>	 $\varnothing 3 \times 25 \text{ mm}$ <b>D3 x 12</b>
 $\varnothing 1,6 \times 25 \text{ mm}$ <b>F x 71</b>	 $\varnothing 8 \times 36 \text{ mm}$ <b>G x 5</b>	 <b>H x 3</b>	 <b>M x 6</b>	 h 7 mm <b>N x 5</b>



# Box 1 / 1



1

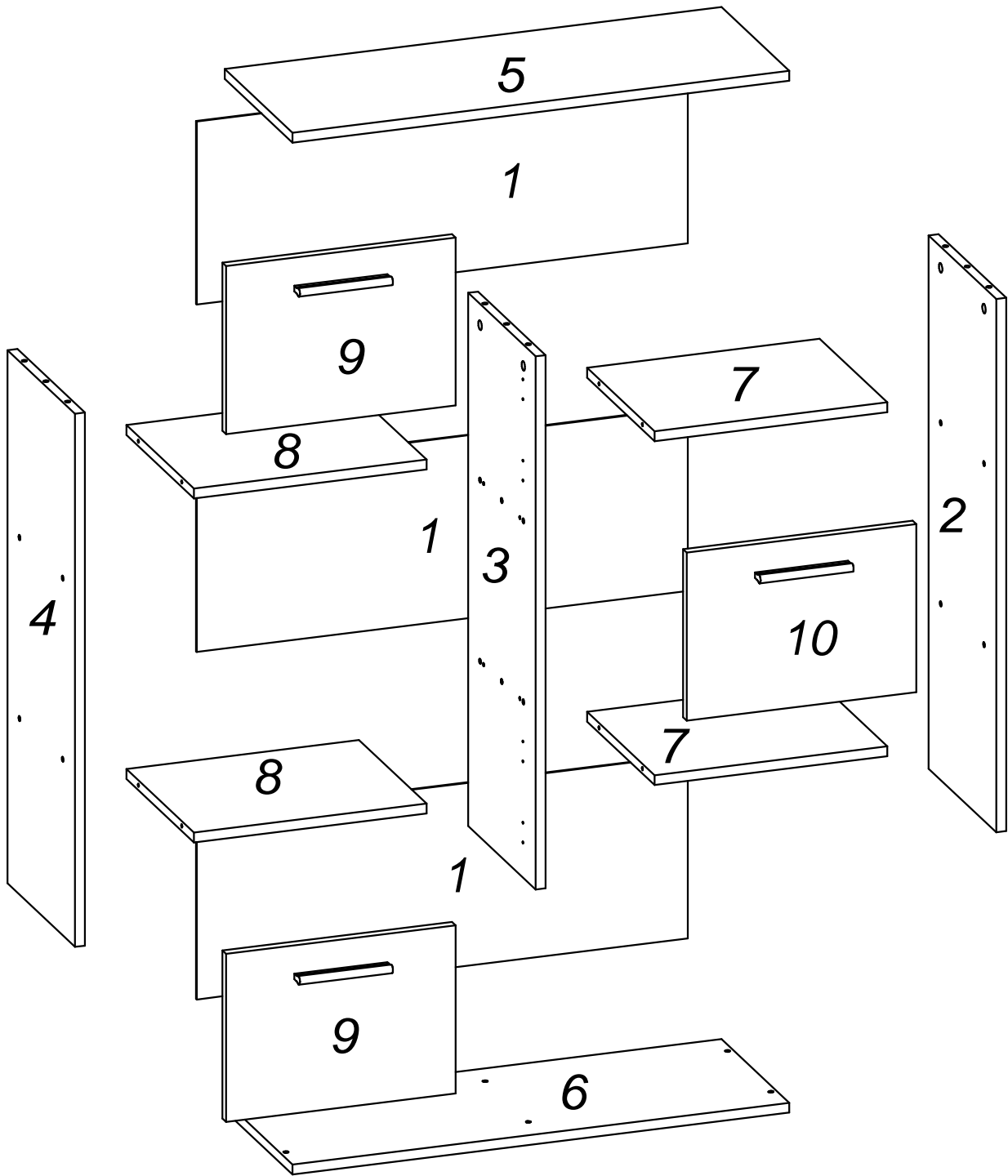
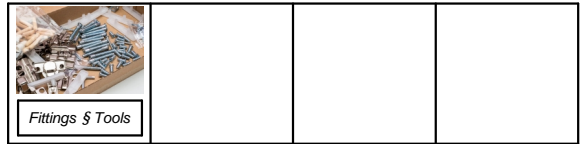
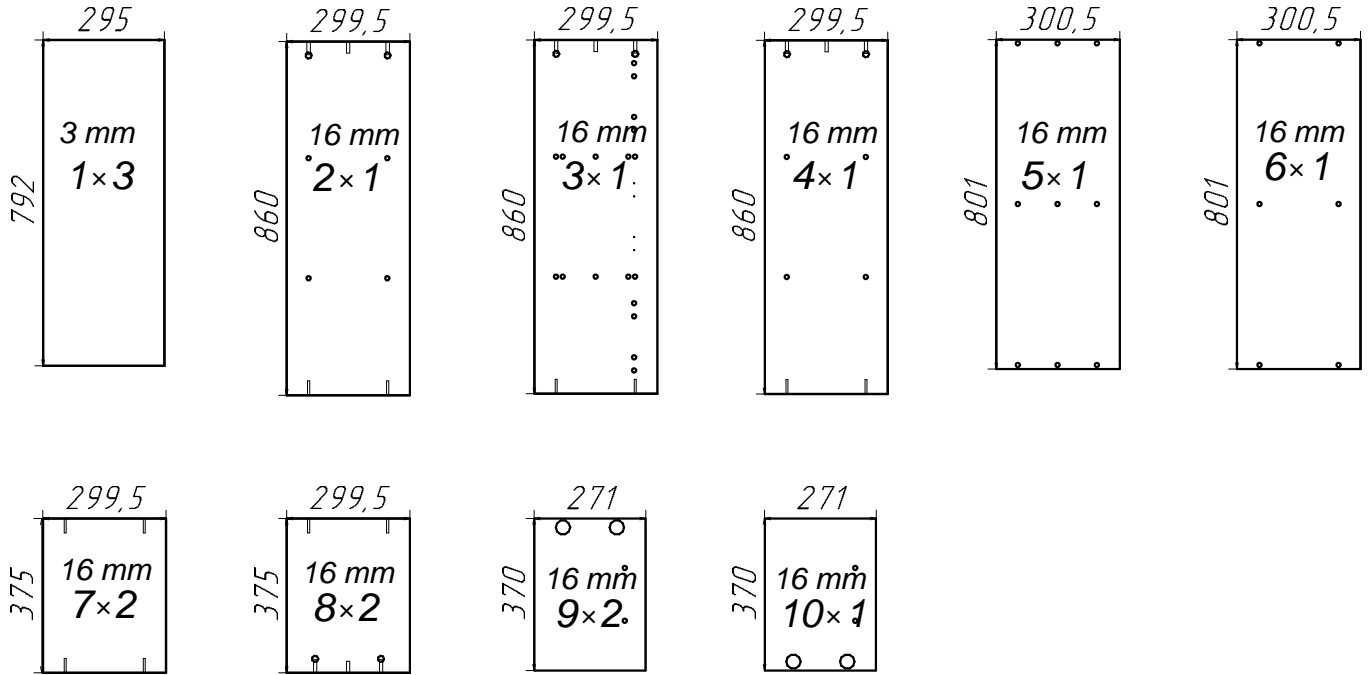
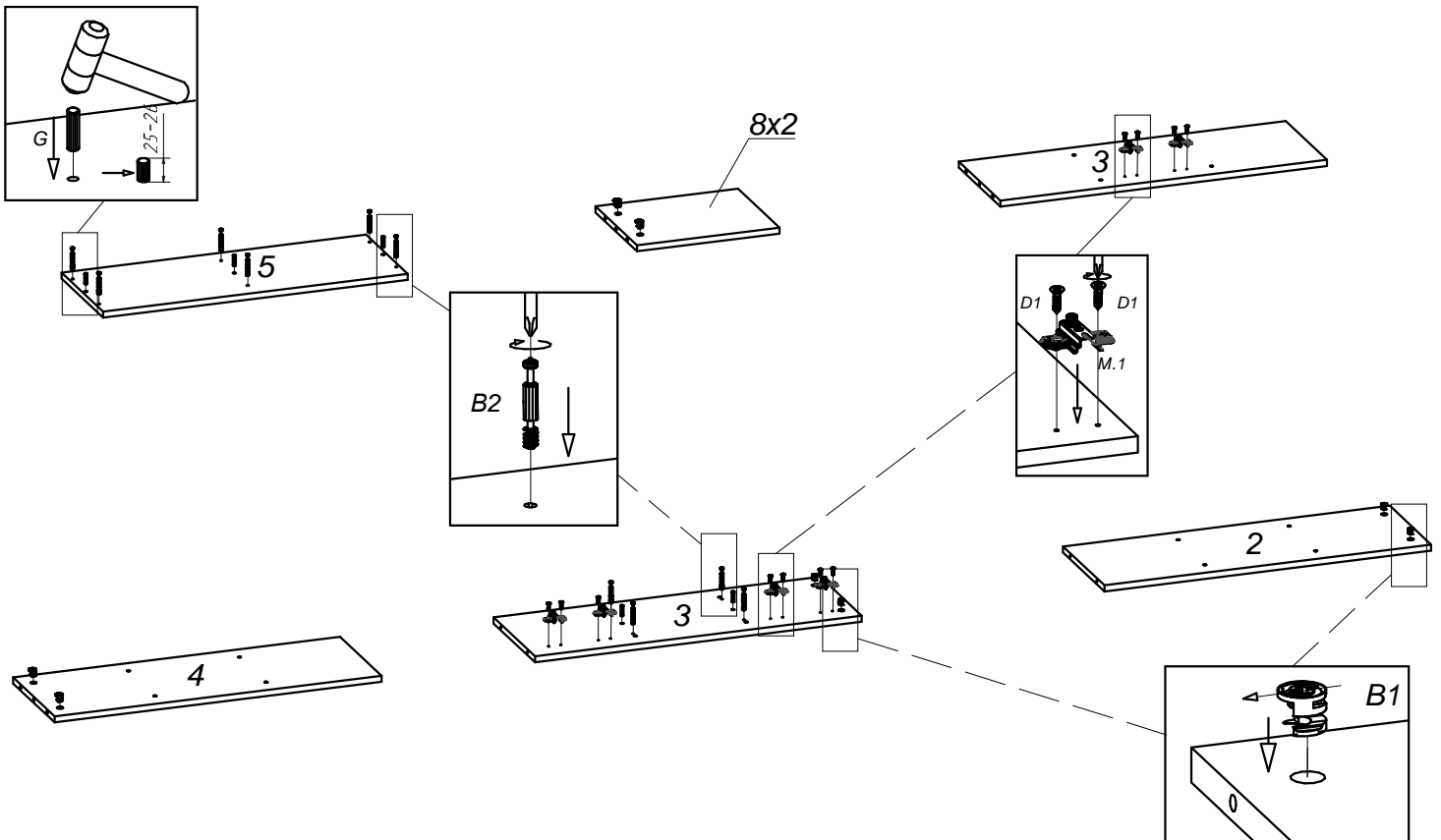

2

  
∅4x16 mm  
D1 x 12

  
M

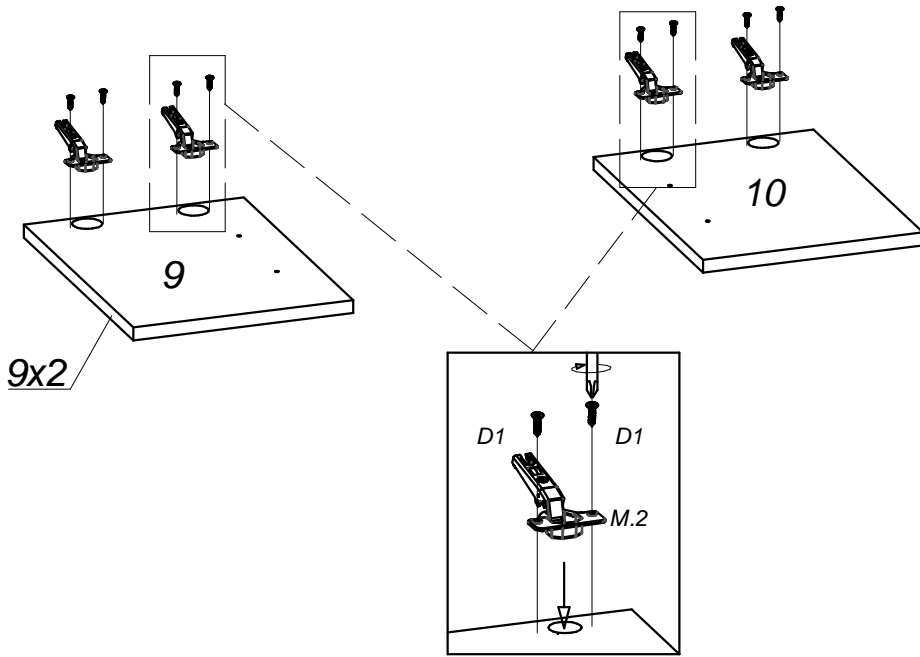

3

  
∅6,3x50 mm  
A1 x 12

  
∅12 mm  
A2 x 12

  
4 mm  
A3 x 1

  
∅20 mm  
B3 x 4

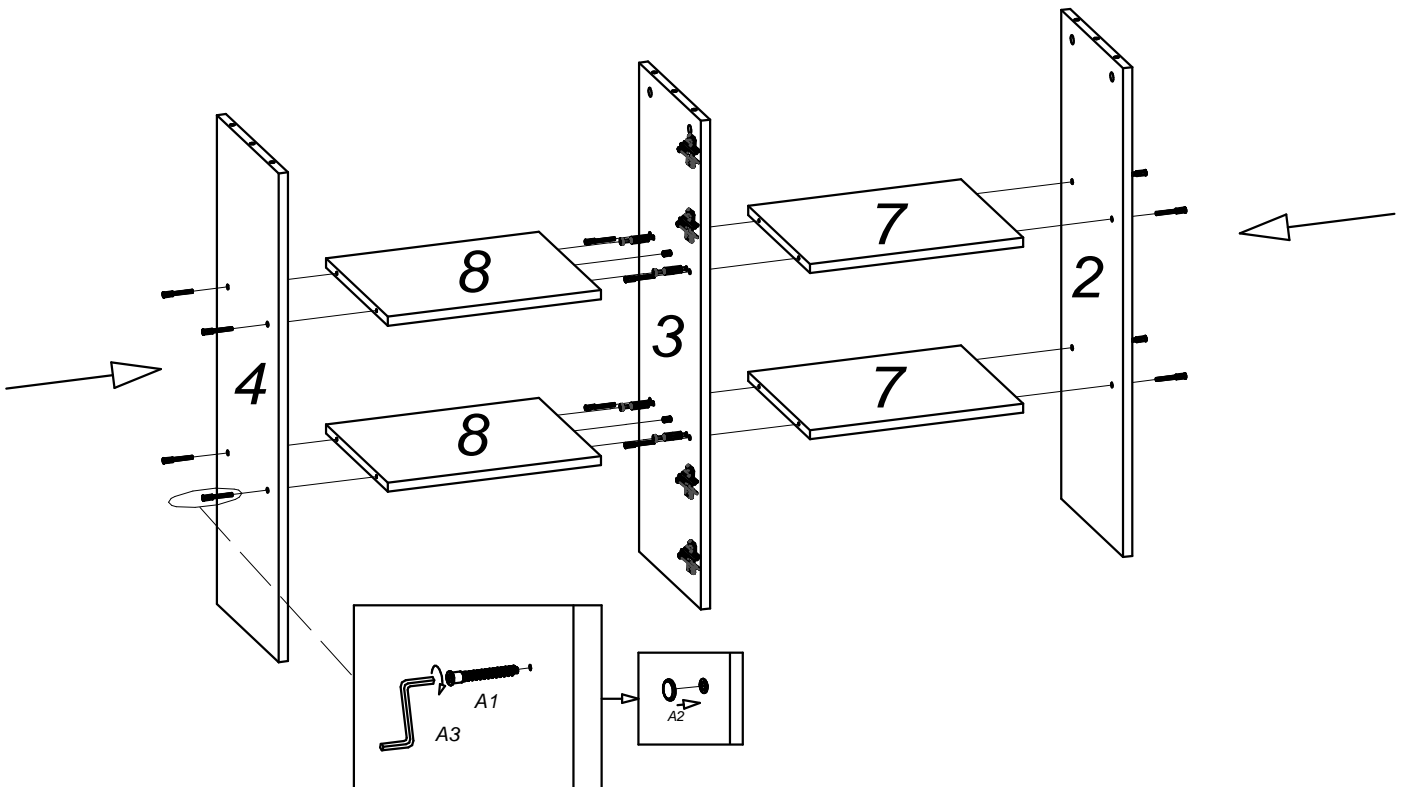

4

 ∅6,3x50 mm A1 x 6	 ∅12 mm A2 x 6	 4 mm A3 x 1	 ∅20 mm B3 x 6					
--	--	--	--	--	--	--	--	--

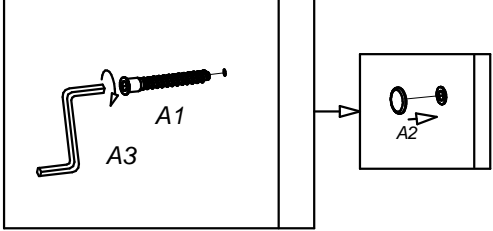
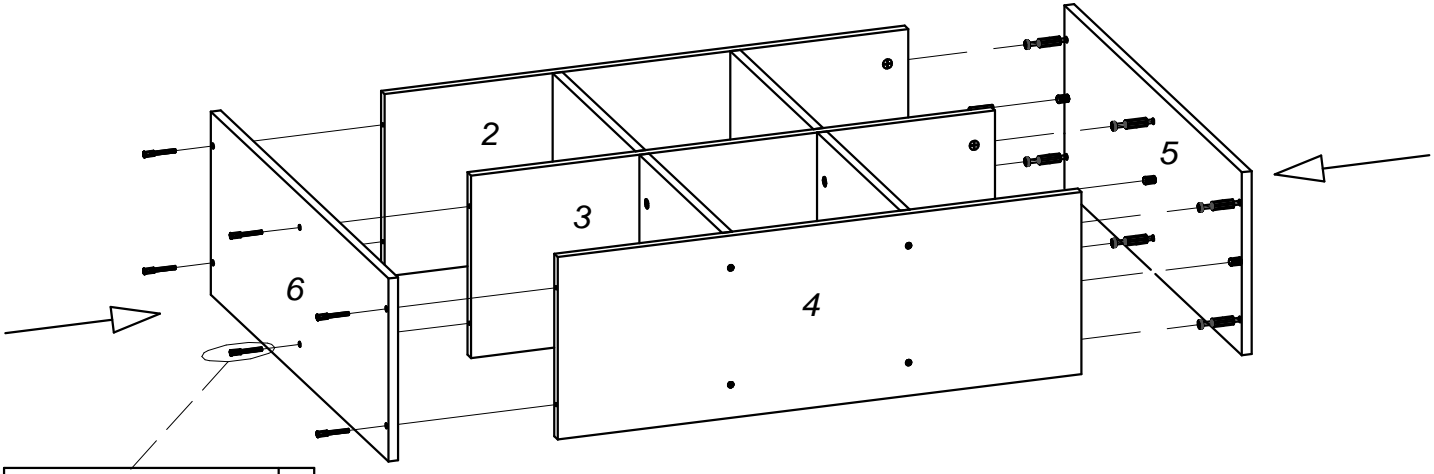

5

 19x14 mm C x 12	 ∅4x16 mm D1 x 10	 ∅3x25 mm D3 x 12	 ∅1,6x25 mm F x 71	 h 7 mm N x 5				
---	--	--	---	--	--	--	--	--

$XX=YY=90^\circ$

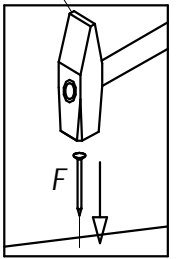
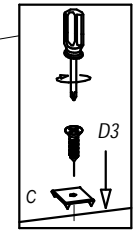
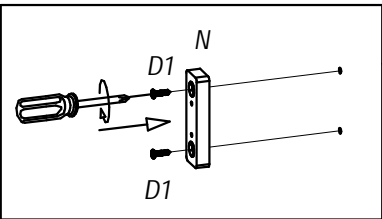
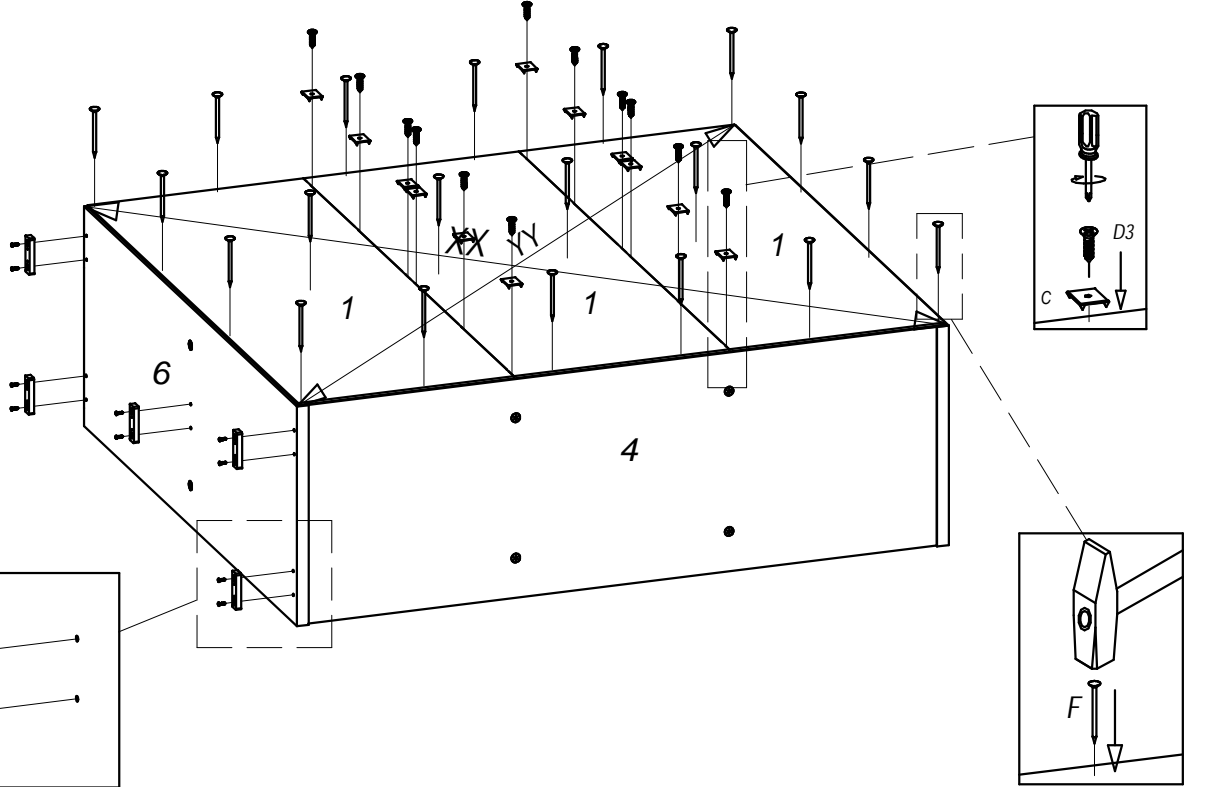

6

